

INSTALLATION INSTRUCTIONS WAINSCOTING WITH PANELS

ORAC[®]
DECOR

INSTALLATIE VAN LAMBRISERING MET PANELEN | INSTALLATION DES LAMBRIS
AVEC PANNEAUX | INSTALLATION VON LAMBRISIERUNG MIT PANEEL |
INSTALACIÓN CON PANELES | INSTALLAZIONE DI RIVESTIMENTI CON PANNELLI |
УСТАНОВКА ПАНЕЛЕЙ СО ВСТАВКАМИ



D503
43 x 43 x 1,7 cm

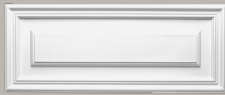

D504
55 x 22 x 1,7 cm



D506
55 x 55 x 1,7 cm



D507
55 x 90,5 x 1,7 cm



WWW.ORACDECOR.COM
>> INSTALLATION

UM403 - 06/2023

1

Ready?

ATMOSPHERE



Storage and installation conditions: Store profiles and adhesives at room temperature and wait 24 hours before installing.
Opslag- en plaatsingsvoorwaarden: Plaats profielen en lijmen 24 uur vóór de installatie op kamertemperatuur.
Conditions d'installation et de stockage: Stockez les profils et les colles à température ambiante 24 heures avant la pose.
Lager- und Installationsbedingungen: Profile und Kleber 24 Stunden vor Verlegung bei Zimmertemperatur lagern.
Condiciones de almacenamiento y de instalación: Colocar molduras y adhesivos en el lugar 24 horas antes de la aplicación.
Condizioni di stoccaggio e di installazione: conservare profili e adesivi a temperatura ambiente e attendere 24 ore prima dell'installazione.
Обязательно оставьте стеновые панели и клей на 24 часа перед монтажом в помещении под отделку.

Ready? Set? Go!

✓ **INSTALLATION
GUARANTEE**

SURFACE



Dust free
Stofvrij
Sans poussière
Staubfrei
Libre de polvo
Privi di polvere
Удалите пыль



Sand and wash surface
Schoor en reinig de ondergrond
Poncez et nettoyez la surface
Schleifen und reinigen Sie den Untergrund
Superficie lisa y limpia
Superficie carteggiata e pulita
Очистите поверхность



Flat wall & ceilings
Vlakte wand en plafond
Mur et plafond plats
Plane Wand und Decke
Paredes y techos lisos
Pareti e soffitti
Выровняйте стены и потолок



Dry
Droog
Sec
Trocken
Seco
Asciutto
Высушите



No grease
Vetvrij
Sans graisse
Fettfrei
Sin grasa
Assenza di grasso
Обезжирьте

2

Set?

DECOFIX ADHESIVES



Online glue calculator
Online lijmcalculator
Calculateur de colle en ligne
Online Klebrechner
Calculadora de adhesivos online
Calcolatore di colla online
Калькулятор клея



Interior, porous and dry surface
Binnen, poreuze en droge ondergronden
Pose à l'intérieur, surfaces poreuses, pièces non humides
Innen, poröse/saugfähig, und trockene Untergründe
Interior, superficies porosas y secas
Superficie interna, porosa e asciutta
Для внутренних работ, пористых и сухих поверхностей



Heavy profiles
Zware lijsten
Grandes moulures
Grosse Profilen
Perfiles pesados
Profili pesanti
Тяжёлые профили

or
of
ou
oder
o
oppure
или

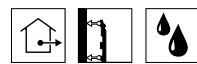

Exterior, non-porous or humid surface
Buiten, niet-poreuze of vochtige ondergronden
Pose à l'extérieur, surfaces non poreuses ou environnement humide
Außen, nicht-poröser/saugfähige Untergrund oder Feuchträume
Exterior, superficies non porosas o ambientes húmedos
Profili pesanti
Superficie esterna non porosa o umida
Для внешних работ, непористых или влажных профилей



Seal wall/ceiling
Verbinding muur/plafond
Collage mur/plafond
Verbindung Wand/Decke
Adherencia techos/paredes
Collante per parete/soffitto
Стены/потолки



DecoFix Pro

Strong, water-based acrylic installation adhesive

FDP500 310 ml > 7 - 8 m
10.5 oz > 23 - 26 ft
FDP600 4200 ml > 65 - 110 m
142 oz > 213 - 361 ft



or
ou
oder
o
oppure
или



DecoFix Power

Very strong MS-Polymer-based installation adhesive

FDP700 290 ml > 7 - 8 m
9.8 oz > 23 - 26 ft



Joints between mouldings
Verbinding tussen profielen
Joints entre les profils
Nahtverbindungen zwischen Profilen
Uniones de los perfiles
Giunte tra i profili
Стыки между профилями



DecoFix Ultra

Polymer-based white adhesive

FX400 270 ml > min. 80 m
9.13 oz > min. 262 ft

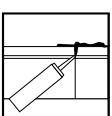

Finish seams with DecoFiller
Werk naden af met DecoFiller
Finissez les coutures avec DecoFiller
Nähte mit DecoFiller versiegeln
Acabar las costuras con DecoFiller
Rifinire le giunte con DecoFiller
Заделайте все швы с помощью DecoFiller



DecoFiller

Ready to use lightweight acrylic filler

FL300 310 ml > 30 m
10.5 oz > 98 ft



INSTALLATION INSTRUCTIONS
WAINSCOTING WITH PANELS

ONLY FULL GUARANTEE WITH DECOFIX

VOLLEDIGE GARANTIE ENKEL BIJ GEBRUIK VAN DECOFIX
 GARANTIE TOTALE UNIQUEMENT AVEC COLLE DECOFIX
 VOLLSTÄNDIGE GARANTIE NUR BEI DER VERWENDUNG VON DECOFIX
 GARANTÍA COMPLETA SÓLO SI SE UTILIZA DECOFIX
 GARANZIA COMPLETA SOLO CON DECOFIX
 ГАРАНТИЯ НА ПРОДУКЦИЮ ДЕЙСТВУЕТ ТОЛЬКО ПРИ ИСПОЛЬЗОВАНИИ КЛЕЯ DECOFIX

Installation of panelled wainscoting | Installatie van lambrisering met panelen | Installation des lambris avec des panneaux |
 Installation von Lambris mit Paneelen | Instalación de arrimadero con paneles | Installazione di rivestimenti a pannelli | Установка
 панелей со вставками

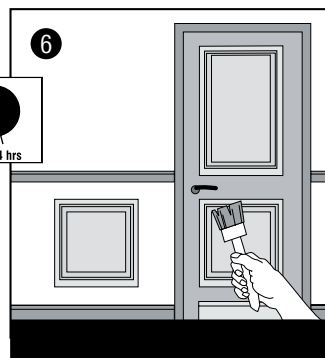
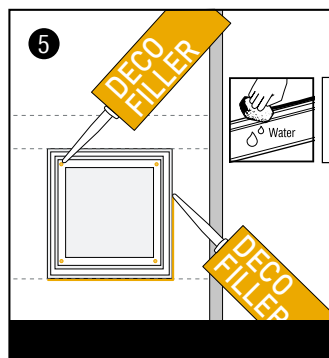
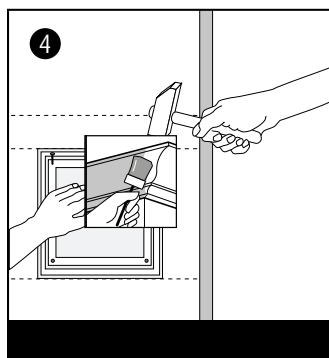
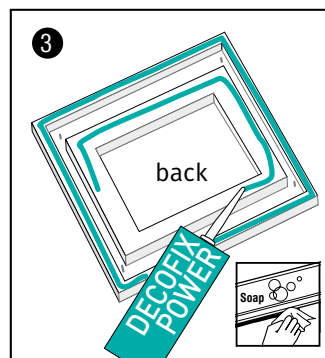
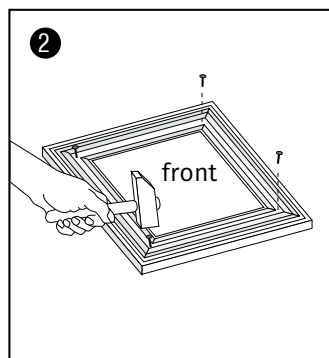
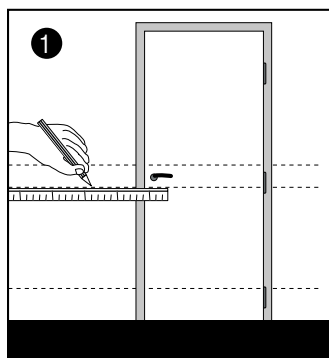
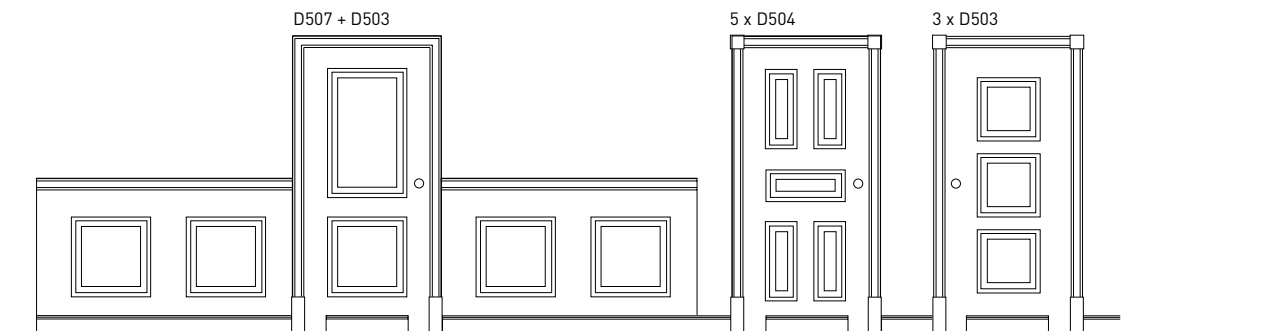

REMOVAL EXCESS ADHESIVE | VERWIJDEREN
 OVERTOLLIGE LIJM | ÉLIMINEZ LES EXCÈS
 DE COLLE | ÜBERSCHÜSSIGEN KLEBER
 ENTFERNEN | ELIMINAR EL EXCESO DE ADHESIVO
 | RIMUOVERE LA COLLA IN ECCESSO | УДАЛИТЕ
 ОСТАТКИ

DecoFix Power: Soap solution | Zeepoplossing |
 Solution savonneuse | Seifenlösung | Agua y jabón |
 Acqua e sapone | Используйте мыльный раствор

DecoFiller: Water | Water | De l'eau | Wasser |
 Agua | Acqua | Вода

MORE INSPIRATION? | MEER INSPIRATIE? | PLUS D'INSPIRATION? | MEHR INSPIRATION? | ¿MÁS INSPIRACIÓN? | PIÙ ISPIRAZIONE? | БОЛЬШЕ ВДОХНОВЕНИЯ?

